



NTS-6002 VERSION 11 HARDWARE MANUAL





CONTENTS

- NTS-6002 at a Glance 3**
- NTS-6002 Overview..... 4**
- Time Signals.....4**
- GPS/MSF Antennas 4**
- Independent Networks 4**
- Technical Specification 6**
- Getting Started 7**
- Equipment Checklist 7**
- Standard Equipment 7**
- Additional Extras 7**
- Installation 8**
- Wiring the Unit 10**
- GPS 10**
- Extending the GPS Antenna with Cat5e/Cat6 Cable..... 10**
- Extending the GPS Antenna with 8-Core Cable..... 11**
- Radio – MSF/DCF/WWVB..... 12**
- Extending the Radio Antenna with Cat5e/Cat6 Cable 12**
- Extending the Radio Antenna with 8-Core Cable 13**
- Configuration..... 14**
- LCD Status 14**
- Set the IP Address Manually..... 15**
- Web Configuration Panel 15**
- Technical Support 16**
- Support Website 16**
- Warranty and Maintenance 18**
- Warranty..... 18**
- Maintenance 18**
- Repair and Returns 18**



NTS-6002 AT A GLANCE

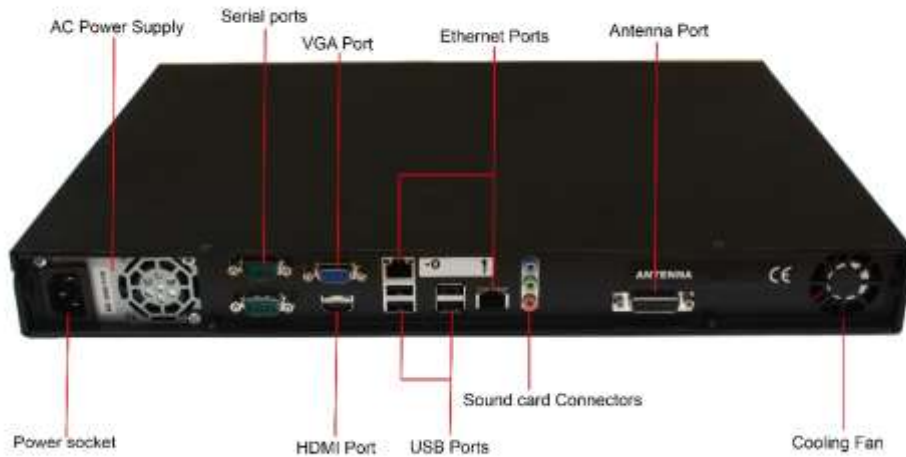



NTS-6002 OVERVIEW

TIME SIGNALS

Incorporating a Linux operating system, the NTS-6002 device synchronises network time from behind a network firewall, sourcing time from up to 12 GPS satellites, or a secondary time receiver, including: the MSF radio signal in Anthorn, UK; the DCF signal in Frankfurt, Germany or the WWVB radio signal in Colorado, USA.

GPS/MSF ANTENNAS

The GPS antenna is fully outdoor ready and functions at its best with a 360° view of the sky. Ideally, the antenna should be positioned on a rooftop for optimum performance. The antenna can be installed up to 500m (1,640ft) away from the time server device, or alternatively, up to 1,000m (3,280ft) if you purchased an optional antenna extension kit.

MSF antennas should be externally mounted on a roof and pointed towards the correct transmitter. However, they can be used indoors in the vicinity of a window.

INDEPENDENT NETWORKS

Featuring dual Ethernet ports, the NTS-6002 can synchronise time across two independent networks and, as a 'stratum 1' device, supplies time to all other devices connected to a network. It can serve time to thousands of devices, handling 500,000 NTP requests per minute.

The device connects directly to a network via a CAT5/CAT6 Ethernet cable [see fig 1] and is designed to fit in a standard 19" [1U] rack [see fig 2].



Figure 1 - A typical CAT5 Ethernet cable



Figure 2 - The NTS-6002 is rack-mountable



- Plug and play installation for set up simplicity, can be configured via a web browser, no knowledge of Linux required
- Front panel display showing antenna status and system information
- Supports over 500,000 NTP requests per minute
- Support for GPS and radio-based synchronisation for redundancy
- Full support for MD5-based authentication and peering with other NTP servers
- Dual Ethernet interface allows for redundancy or can be used to keep the public and private networks separate
- Upgradable flash memory allows for a unit in a locked down environment to receive software updates
- For security, the unit is locked down. All unnecessary services are disabled and the unit utilises HTTPS and TLS to protect passwords



Figure 3 - NTS-6002-GPS



TECHNICAL SPECIFICATION

Protocols - NTP & SNTP	NTP v2 (RFC 1119) NTP v3 (RFC 1305) NTP v4 (RFC 2131) SNTP v3 (RFC 1769) SNTP v4 (RFC 2030)
Configuration	Across a Network via Secure Browser (https://) (RFC 2616) Secure Shell (SSH)
Technical Standard	NMEA 0183 V.2 Compliant
SNMP	Simple Network Management Protocol (Can be switched off)
Network Interface	Standard 10/100/1000 Base-T, Dual RJ-45 Network Connections
MTBF Estimated	45,000
Display	LCD with Backlight
Operating System	Linux Based
Operating Temperatures	0-50°C (32-122°F)
Heat Dissipation	150 BTU Per hour
Humidity	Max. 85% Non-Condensing
Housing	Standard 19" rackmount (1U)
Function	Stratum 1 Time Server, Secure Shell (SSH) and HTTPS
Network Accuracy	Network: 1-10 Milliseconds, Typical GPS/Radio: <1 Microseconds, Relative to UTC
Security	MD5 Authentication
NTP Time Requests	500,000 per minute
Power Supply Universal	85-260V, 47-63Hz
Power Consumption	27 Watts
Dimensions (mm) Packed	Packed Up: (H) 160 (W) 620 (D) 630
Unpacked	Unpacked 1U: (H) 45 (W) 425 (D) 309
Properties	Powder Coated Steel
Weight Packed	7.6kg
Unpacked with Antenna	4.8kg
Source	GPS Satellite Radio
External	Active 12 Channel GPS MSF/DCF/WWVB Antenna



GETTING STARTED

EQUIPMENT CHECKLIST

Standard Equipment

- ✓ NTS-6002 rack-mount unit.
- ✓ IEC power cable.
- ✓ GPS or MSF or DCF or WWVB antenna. *
- ✓ Junction Box and IDC Cable Tool.
- ✓ Mounting bracket and fixing for antenna.
- ✓ USB containing manual and software.



Figure 4 - Your GPS Package

Additional Extras

- ✓ Lightning Arrestor(s).
- ✓ Cable for extending the antenna(s).
- ✓ Gold and Premium Support.
- ✓ Digital Wall Clock - Ethernet Powered.
- ✓ Secondary Time Source Available.
- ✓ Antenna Cable - Available from 100 to 1,000 metre rolls.
- ✓ Additional Power Supply - Recommended from 500 metres onwards.

*The antennas provided will depend on which has been ordered, however, all units come with at least one antenna.



Figure 5 - Your MSF/DCF/WWVB Package



INSTALLATION

- Position the NTS-6002 on a rack-mount shelf or another convenient location. Note – you will need to run a cable from this location either to the roof or a window.
- Once positioned, connect the AC power cord [see fig 6] at the back of the device and plug into your electrical outlet.



Figure 6 - AC Power Cord

- Then, connect the device to a network using a standard RJ-45 cable [see fig 7]. If your network supports Dynamic Host Configuration Protocol [DHCP], the NTS-6002 will automatically obtain an IP Address. For use across an additional network, connect a second RJ-45 cable to the second port on the device.



Figure 7 - RJ-45 Ethernet Cable

- You're now ready to connect the antenna [see fig 8 for GPS and fig 9 for Radio]. Connect the antenna cable to the input port marked 'Antenna' [refer to page 3 - NTS-6002 'At a Glance' – for guidance]. For optimum GPS antenna performance, mount on a roof. For optimum Radio antenna performance, mount on a roof and point towards correct transmitter.*

Ensure that you leave enough slack cable to reposition the NTS-6002 device if needed and remember, the cable distance should not exceed 1,000m.

***Note – avoid positioning antennas in the proximity of air conditioning systems and power distribution units as they will cause electrical interference.**



Figure 8 - GPS Antenna



Figure 9 - Radio Antenna

Extending the cable [see pages 10-13 for additional information] - If you are extending the cable to a length of 500m or more then you will need an extra power source, located either on the roof, or accessible from the roof.



WIRING THE UNIT

GPS

Extending the GPS antenna with Cat5e/Cat6 cable

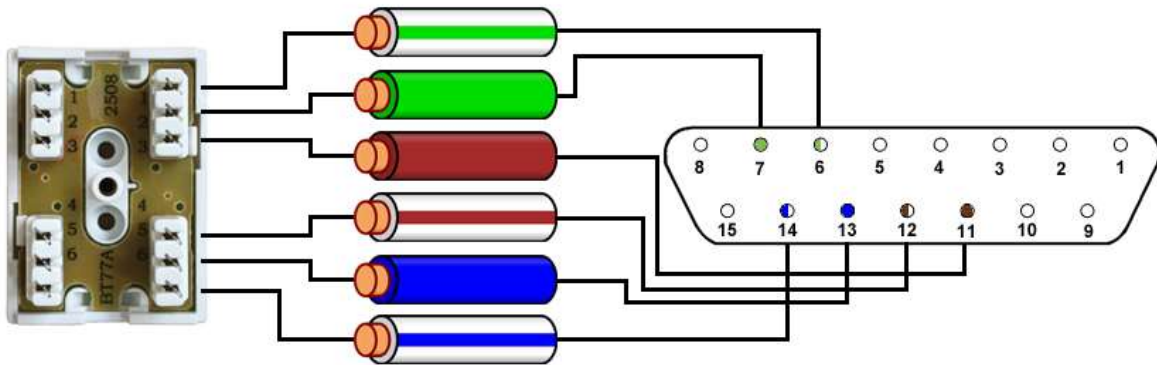
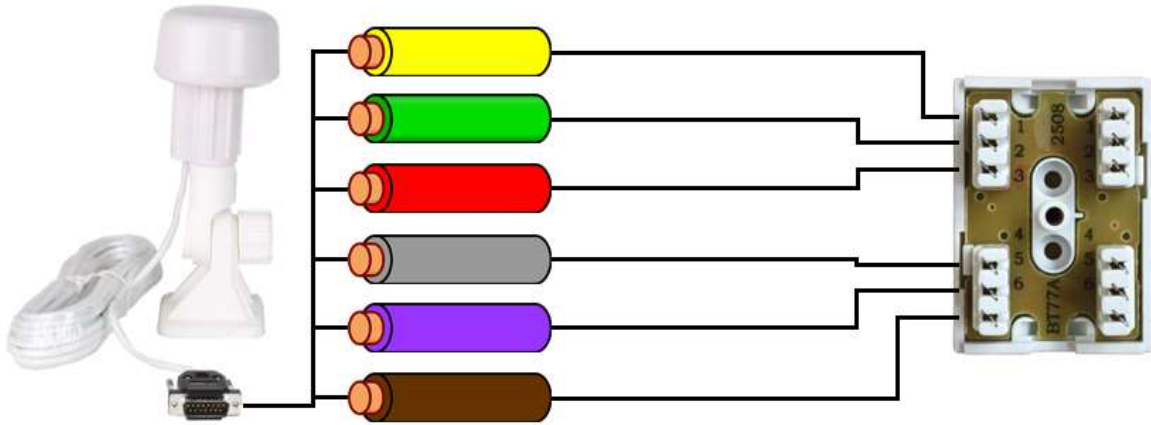

15 Way D-Type Pin	Cable Colour
6	Green/White
7	Green
11	Brown
12	Brown/White
13	Blue
14	Blue/White



Extending the GPS antenna with 8-core cable

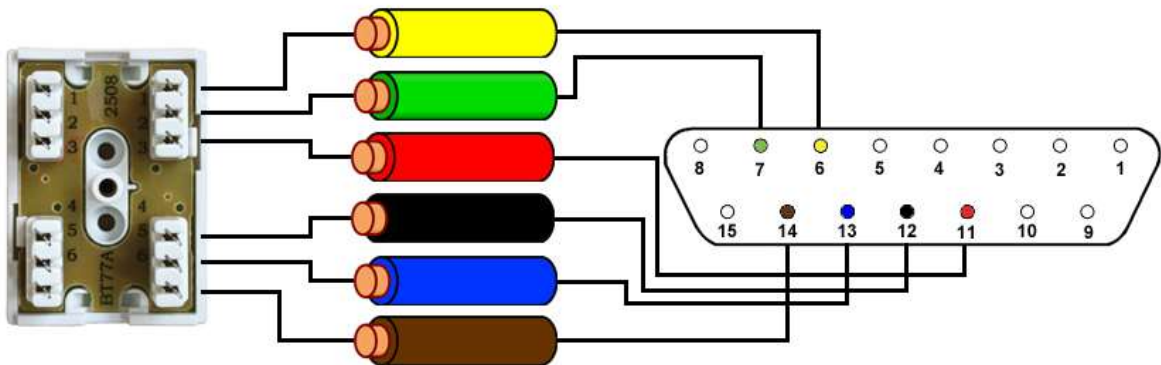
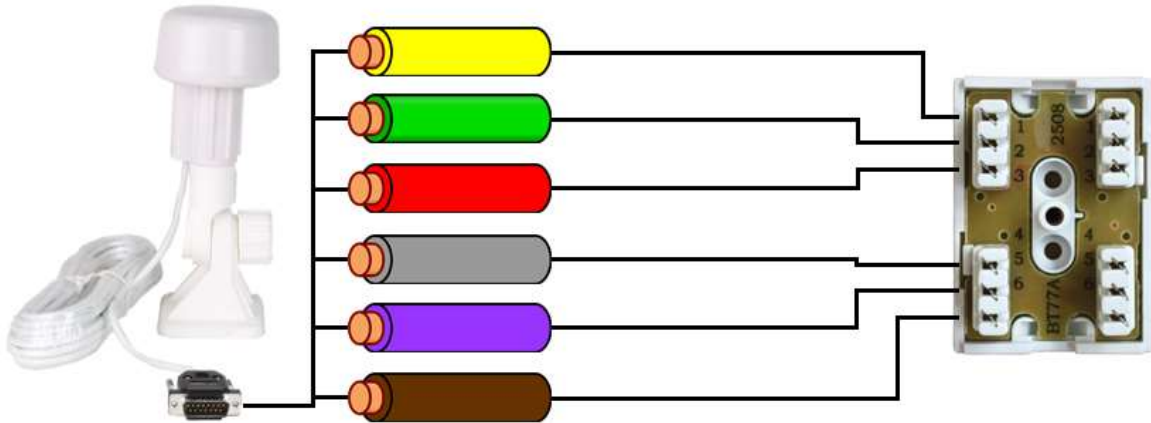

15 Way D-Type Pin	Cable Colour
6	Yellow
7	Green
11	Red
12	Black
13	Blue
14	Brown



RADIO – MSF/DCF/WWVB

Extending the Radio antenna with Cat5e/Cat6 cable

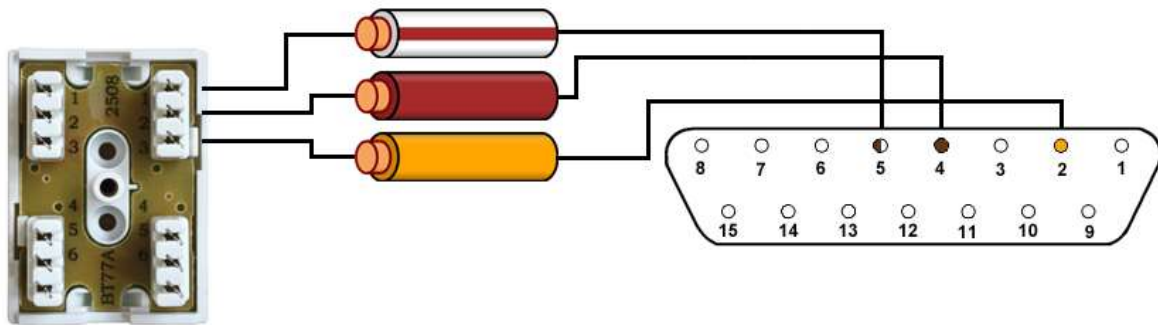
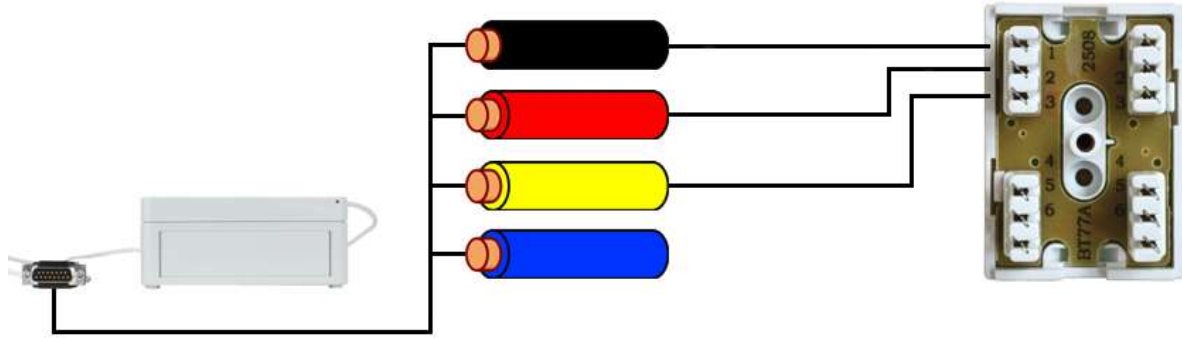

15 Way D-Type Pin	Cable Colour
2	Orange
4	Brown
5	Brown/White



Extending the Radio antenna with 8-core cable

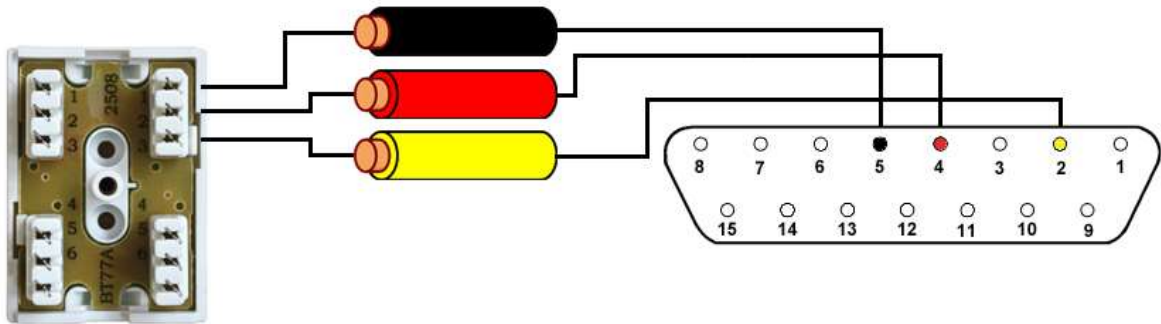
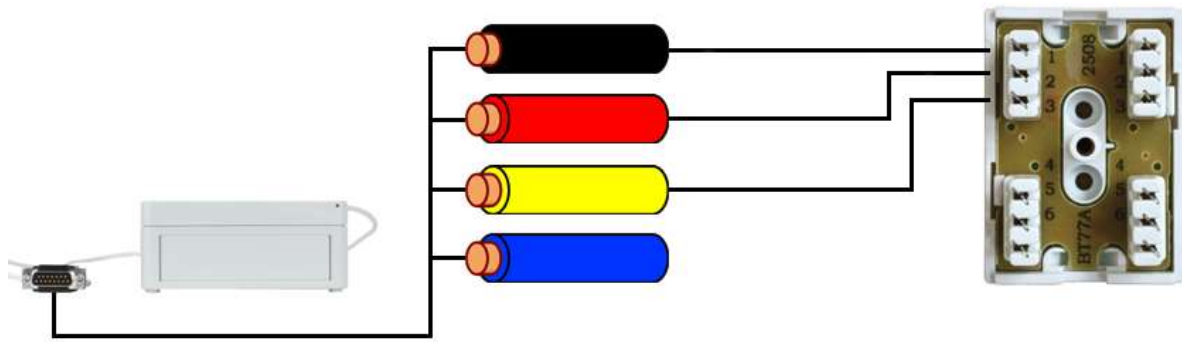

15 Way D-Type Pin	Cable Colour
2	Yellow
4	Red
5	Black



CONFIGURATION

LCD STATUS

After connecting all components, power up the device for it to begin running the necessary configuration processes. The LCD display will activate and show the following:

- LCD INITIALISED
- ASMINT DISPON 20M

Next, the unit will check for data coming into the serial connector:

- WAITING SERIAL DATA

The unit will display the current software version:

- Software Version 11

A time and date will then be displayed:

- Fri Jul 15 13:54:59

And the unit will seek to synchronise with either GPS or Radio:

- Waiting for 1st sync
- Fri Jul 15 13:56:30

During the waiting period for synchronisation, the unit will remain in an 'unsynchronised state':

- Unsynchronised
- Fri Jul 15 13:57:19

The unit will show that it 'knows' there is an antenna attached:

- GPS Antenna OK
- Fri Jul 15 13:58:31

Once in a 'synchronised state', the unit will display:

- Synchronised (GPS)
- Fri Jul 15 13:59:58

In this state, the display will show the GPS/Radio information as well as the date and time.

At all times, the unit will display the IP Address in the message cycle.



SET THE IP ADDRESS MANUALLY

To set the IP Address of the NTS-6002 manually, first you must plug a standard USB keyboard into the device before powering on. Then, do the following:

Type D

Press Enter

Set the Edit DHCP to N

Press Enter

Type S to save

Type I to Edit IP Address

Press Enter

Type in new IP Address (xxx.xxx.xxx.xxx)

Press Enter

Type S to save

Type M to Edit Subnet Mask

Type in the Subnet Mask (xxx.xxx.xxx.xxx)

Press Enter

Type S to save

Type G to Edit Gateway

Type in the Gateway (xxx.xxx.xxx.xxx)

Press Enter

Type S to save

Reboot the System

WEB CONFIGURATION PANEL

Please refer to the Web Configuration manual for help in accessing the Web Configuration Panel for your unit. Here, you will be able to edit more information and take advantage of all the unit's standard and advanced features, including; SNMP and NIC Teaming.



TECHNICAL SUPPORT

SUPPORT WEBSITE

For NTS-6002 technical support, please go to galleonsupport.com and in the first instance, use the 'Knowledgebase' to resolve technical issues.

If you're unable to resolve an issue using the Knowledgebase, submit a support ticket. Outline the problem with the device, providing as much information as possible, and the Technical Support Team will contact you.

The more information provided, the quicker a problem can be diagnosed and remedied.

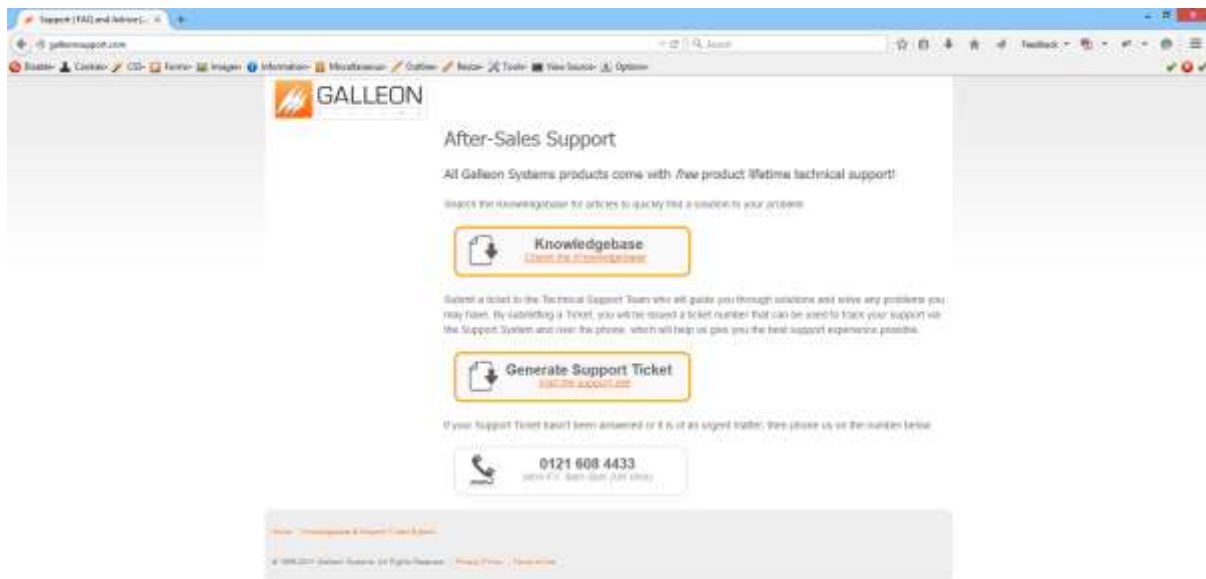

Figure 10 - Access the Knowledgebase and Ticket System via galleonsupport.com

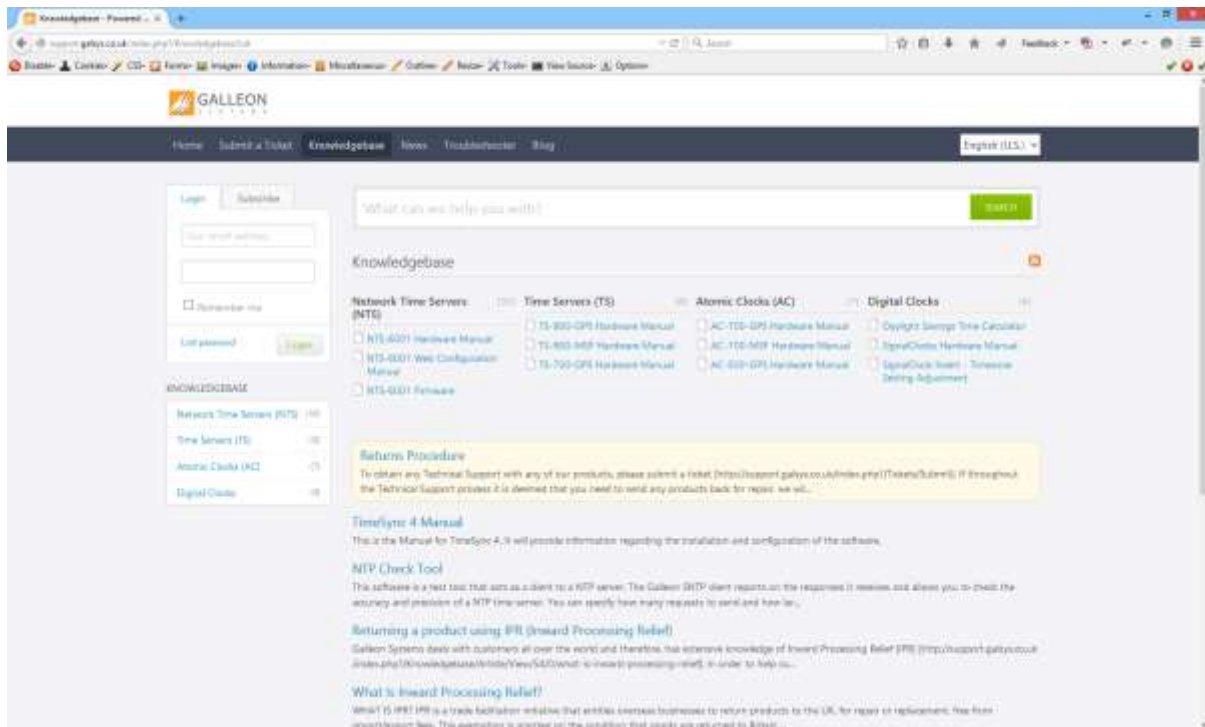

Figure 11 - Use the 'Knowledgebase' resource to resolve technical problems.

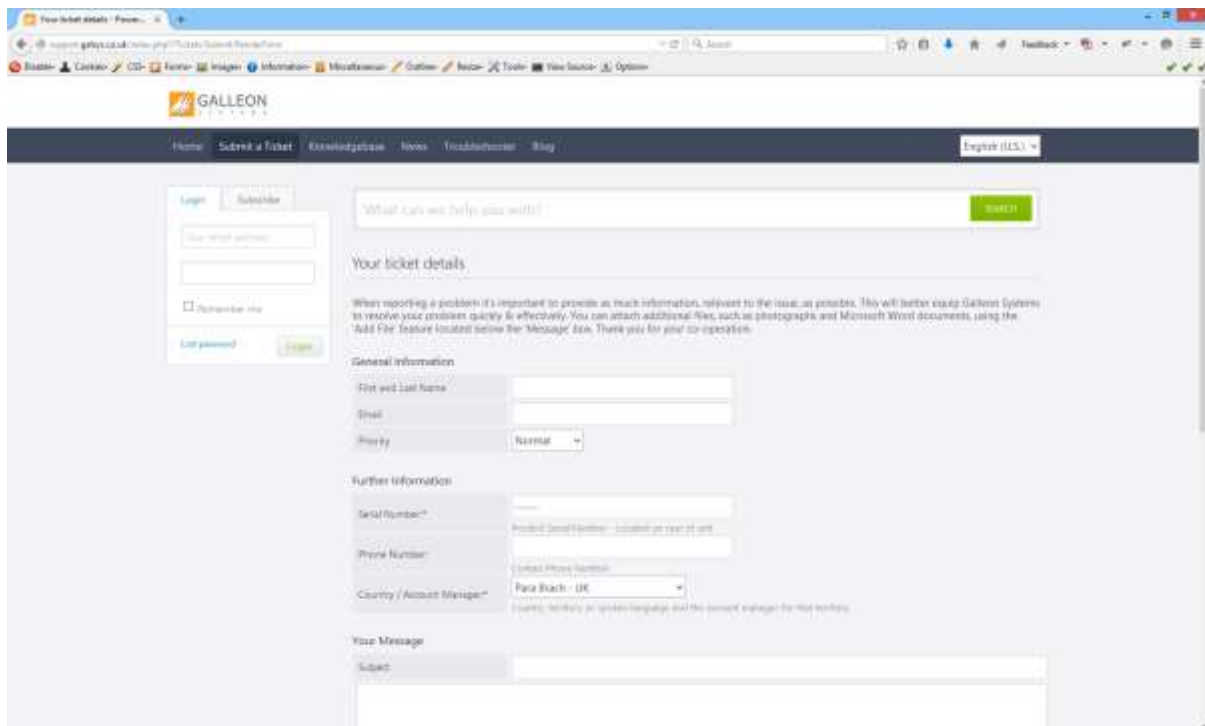

Figure 12 - To speak to the Technical Support Team, submit a ticket.



WARRANTY AND MAINTENANCE

WARRANTY

The NTS-6002 time server comes with an industry leading, six year warranty. Warranties commence on the date a unit is shipped by Galleon Systems. Extended warranties are available on request. To extend your warranty, call 0121 608 7230.

In accordance with the terms of the warranty, Galleon Systems' liability is limited to repairing or replacing, at the discretion of Galleon Systems, the defective equipment and providing upgraded version changes for firmware. In case of repair, the product must be returned to Galleon Systems.

This warranty does not apply if repairs are required due to acts of nature beyond Galleon Systems' control such as, but not limited to:

- Lightning strikes
- Power surges
- Misuse, damage or neglect or
- If repairs/modifications have been made or attempted by anyone other than personnel authorised by Galleon Systems

Under no circumstances will Galleon Systems be liable for any indirect, special, incidental or consequential damages from the sale or use of this product.

This disclaimer applies both during and after the term of the warranty. Galleon Systems disclaims liability for any implied warranties, including implied warranties of merchantability and fitness for a specific purpose.

MAINTENANCE

The NTS-6002 should be positioned in a secure location, away from any potential damage threats. Antennas should not be positioned in the vicinity of instruments likely to cause signal interference, for example, air conditioning systems.

The NTS-6002 device is a 'set it and forget it' device, but external antennas should be checked regularly, particularly after bad weather. Cleaning of the time server device should be done with a dry, anti-static cloth to remove dust.

REPAIR AND RETURNS

If it's deemed that your device requires repair, having exhausted the Technical Support process, Galleon Systems will issue a Return Material Authorisation [RMA] number complete with shipping instructions, then ship the product, transportation prepaid, for inspection.

Typical equipment repair or replacement time is five (5) business days, plus shipping times.

One-way shipping remains the responsibility of the customer. Galleon Systems will return equipment by the same method it was received.

Galleon Systems will not be responsible for unauthorised returns or returns that fail to specify the RMA number on a packing list, attached in plain view, on the outside of the shipping container.